



Town of Wright  
395 Lariat Way  
Wright WY 82732  
Ph. 307-464-1666

# RESIDENTIAL BUILDING REQUIREMENTS



## Residential Building Requirements

Inspection services for the Town of Wright are provided by the Campbell County Public Works Building Division. This informational booklet is provided by Campbell County with general residential construction requirements taken from the codes adopted by the Town of Wright, the 2018 International Residential Code, and the 2020 National Electric Code. This booklet is not all-inclusive and should not

be used as a design specification or instruction manual. For specific or additional information you may contact the Campbell County Public Works Building Division at 307-682-1970.

### Climatic and Geographical Design Criteria

Minimum Roof Snow Load (psf)	Basic Design Wind Speed Per IBC 1609.3 Wind Speed 115 Nom. 90 mph	Seismic Design Category	Subject to Damage From			Winter Design Temp (°f)	Ice Barrier Underlayment Requirements	Flood Hazards	Air Freezing Index	Mean Annual Temp (°f)
			Weathering	Frost Line Depth (in.)	Termite					
30-35*	Exp.C	B	Severe	42	Slight / moderate	-5	Yes	Jan. 02 2008	2000	45

1:12 pitch and flatter, 35 psf. 1:12 pitch and greater, 30 psf.

#### Light, Ventilation and Heating:

- All habitable rooms shall have an aggregate glazing area of not less than 8 percent of the floor area of such rooms.
- Natural ventilation shall be through windows, doors, louvers or other approved openings to the outdoor air. The minimum open able area to the outdoors shall be 4 percent of the floor area being ventilated.
- Every dwelling unit shall be provided with heating facilities capable of maintaining a minimum room temperature of 68 degrees 3 ft. above the floor and 2 ft. from exterior walls in all habitable rooms.
- Minimum ceiling height:
- Habitable space, hallways, and portions of basements containing these spaces shall have a ceiling height of not less than 7 feet.
- Basements without habitable spaces shall have a ceiling height of at least 6 ft. 8 inches.
- For rooms with sloped ceilings, at least 50 percent of the floor area must have a ceiling height of at least 7 ft. and no portion shall have a ceiling height of less than 5 ft.

Garages:

- The garage shall be separated from the dwelling and its attic area by ½ inch gypsum board applied to the garage side. Garages beneath habitable rooms shall be separated from rooms above by 5/8-inch type X gypsum board.
- Openings from garages into sleeping rooms shall not be permitted. Other opening between garages and dwellings shall be equipped with solid wood doors not less than 1 3/8 inches thick, solid or honeycomb core steel doors not less than 1 3/8 inches thick, or 20-minute fire-rated doors. (see figure R302.5.2)
- Garage floors shall be of approved noncombustible material.

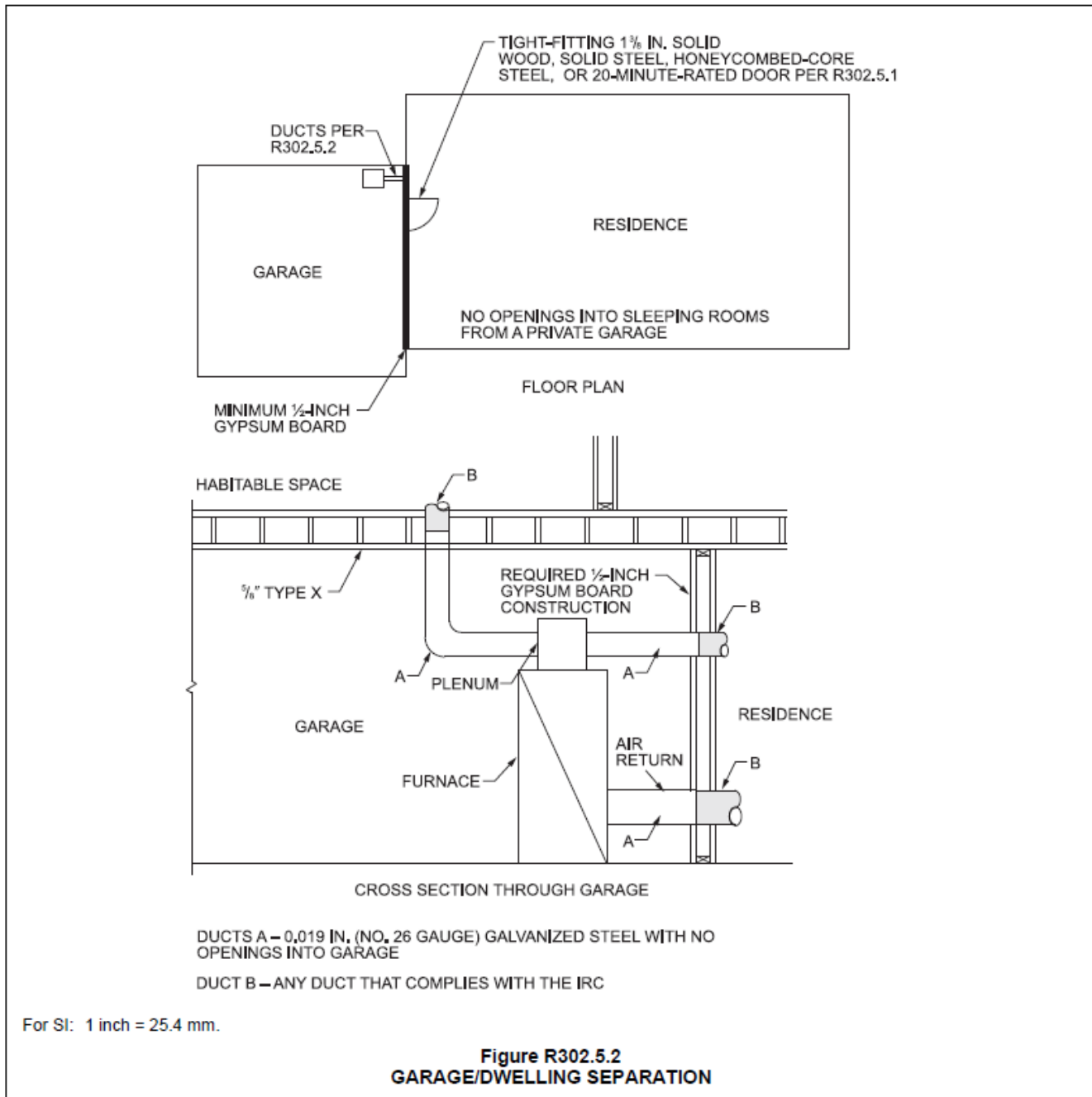

Emergency escape and rescue openings:

- Basements and every sleeping room shall have at least one emergency escape and rescue opening. The opening shall open into a public street, alley, yard or court. The openings shall have a sill height of no more than 44 inches above the floor. Openings shall have a minimum net clear opening of 5.7 sq. ft. The minimum net clear opening height shall be 24 inches. The minimum net clear opening width shall be 20 inches. Exception: Grade floor or below grade openings shall have a net clear opening of not less than 5 sq. ft. (See figure 310.2.1)

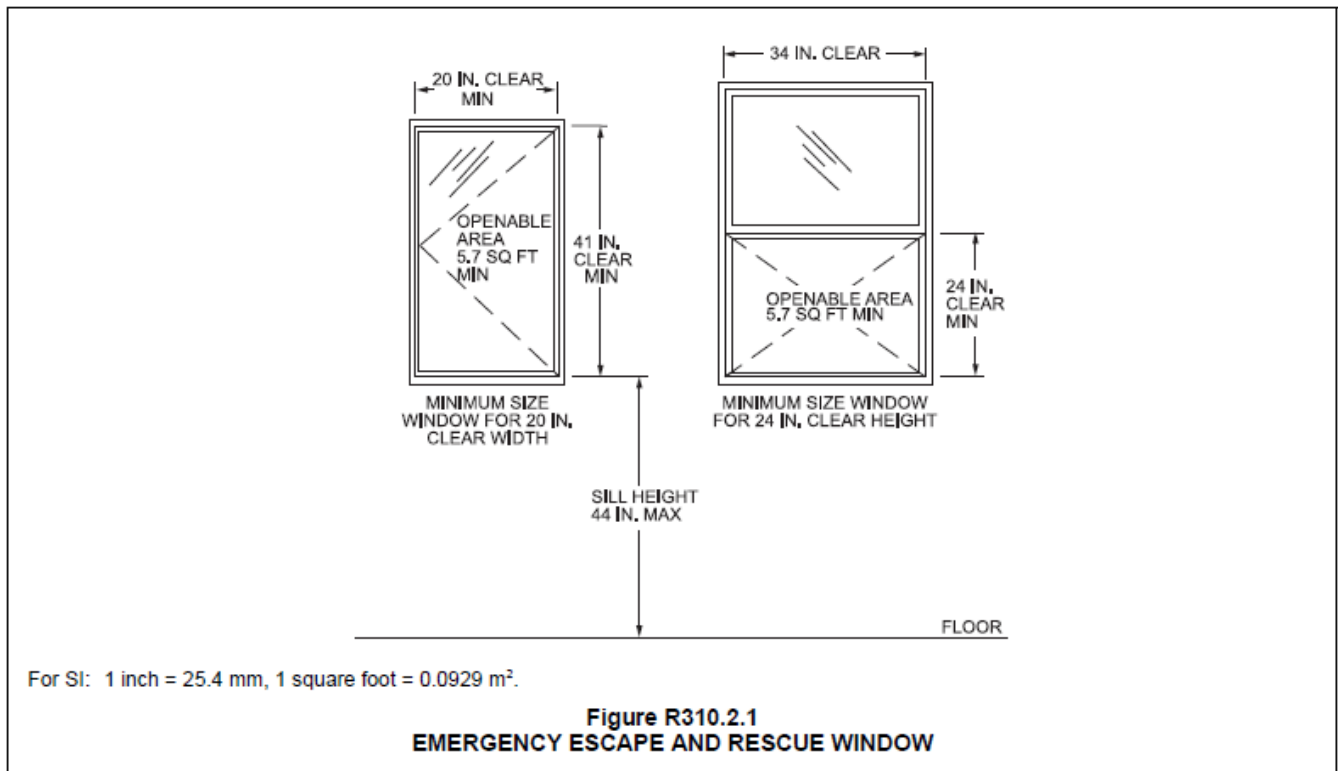

Window wells:

- The minimum horizontal area of the window well shall be 9 sq. ft. with a minimum horizontal projection and width of 36 inches. The area of the window well shall allow the emergency escape and rescue opening to be fully opened.
- Window wells with a vertical depth of greater than 44 inches shall be equipped with a permanently affixed ladder or steps usable with the window in the fully open position. Ladders or rungs shall have an inside width of at least 12 inches, shall project at least 3 inches from the wall and shall be spaced not more than 18 inches on center vertically for the full height of the window well. (see figure R310.2.3)

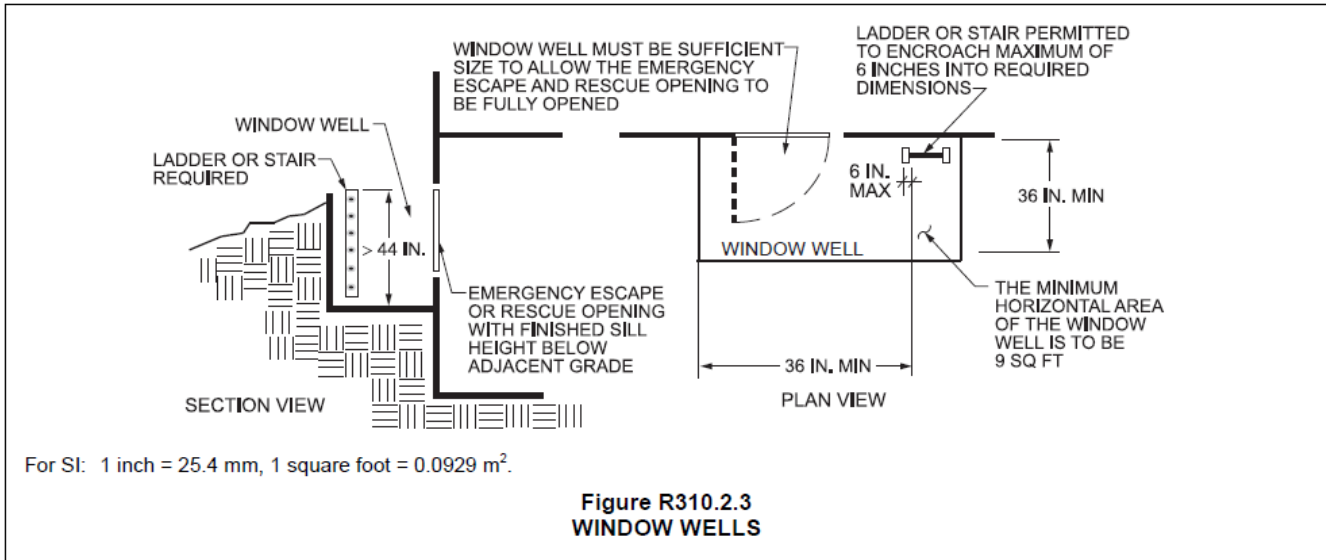

Means of egress:

- Hallways and stairways shall have a minimum width of 36 inches.
- At least one exit door is required for each dwelling. The door shall be a side-hinged door a minimum of 32 inches wide by 6 ft. 6 inches in height.
- There shall be a floor or landing on each side of each exterior door. The floor or landing shall not be more than 1 ½ inches below the threshold. The landing on the exterior side can be no more than 7 ¾ inches below the top of the threshold, provided the door, other than screen or storm door does not swing over the landing.
- Where a stairway of two or fewer risers is located on the exterior side of a door, other than the required exit door, a landing is not required for the exterior side of the door provided the door, other than a storm or screen door does not swing over the stairway.
- The minimum width of every landing shall not be less than the door or stairway served. The minimum distance measured in the direction of travel shall be 36 inches.
- Stairways shall have a minimum required ceiling height of 6 ft. 8 inches. The maximum riser height shall be 7 ¾ inches. The greatest riser height in any flight of stairs shall not exceed the smallest by more than 3/8 inch. (see figure R311.7.2(1) for headroom)

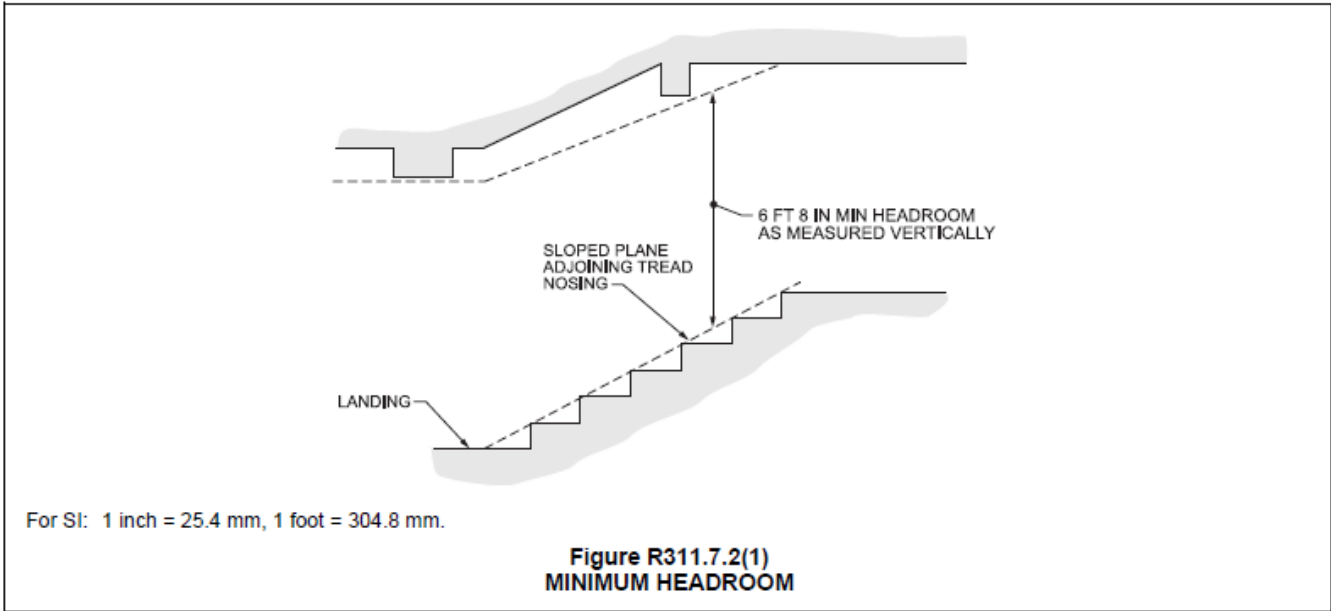

- The minimum tread depth shall be 10 inches. The greatest tread depth in any flight of stairs shall not exceed the smallest by more than 3/8 inch. (see figure R311.7.5.1(1) for risers)

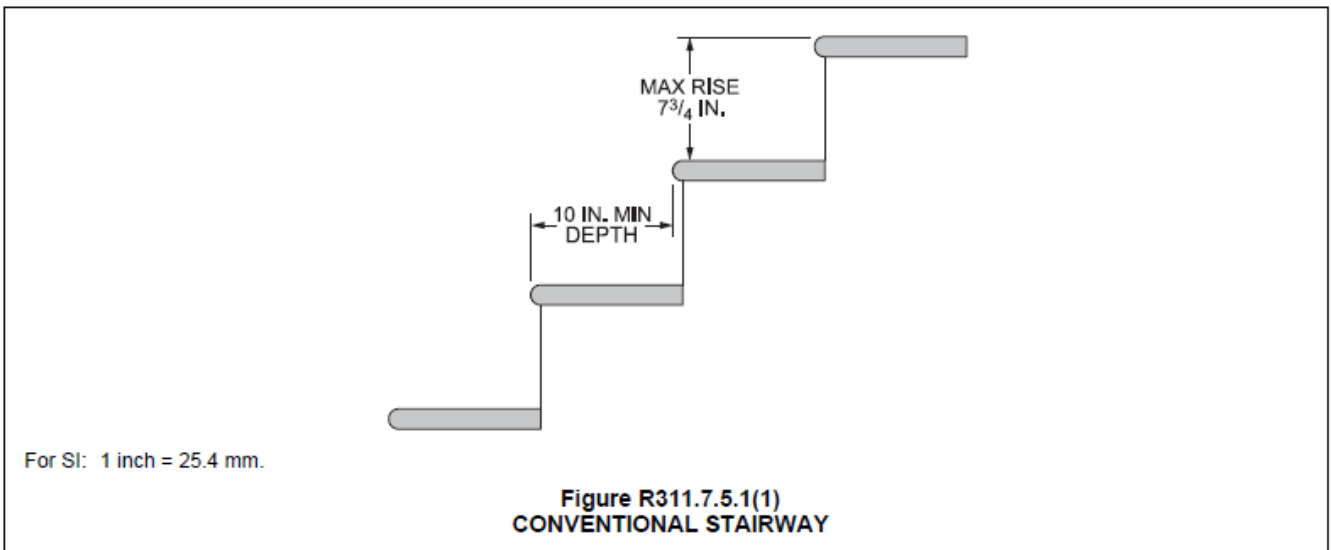

- There shall be a floor or landing at the top and bottom of each stairway.
- Exception: A floor or landing is not required at the top of an interior flight of stairs, including stairs in an enclosed garage, provided a door does not swing over the stairs.
- Enclosed accessible space under stairs shall have walls, under stair surface and any soffits protected on the enclosed side with 1/2 inch gypsum board.

**Handrails:**

- Handrails shall be provided on at least one side of each continuous run of treads or flight with four or more risers. Handrail height, measured vertically from the sloped plane adjoining the tread nosing, shall be not less than 34 inches or more than 38 inches. Handrails shall be continuous for the full length of the flight from the top riser to the bottom riser. Handrail ends shall be returned or shall terminate in newel posts or safety terminals. (see figures R311.7.8.3 ( 1), R311.7.8.3(2) and R311.7.8.2 for handrails)

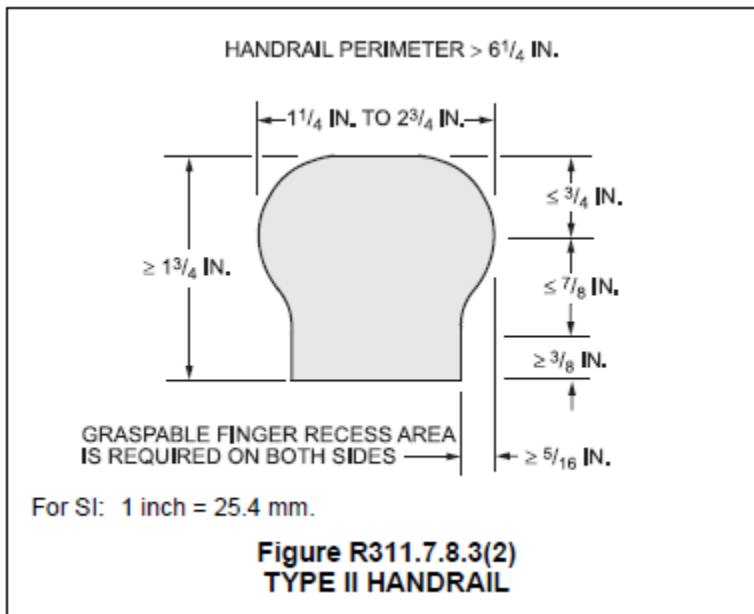
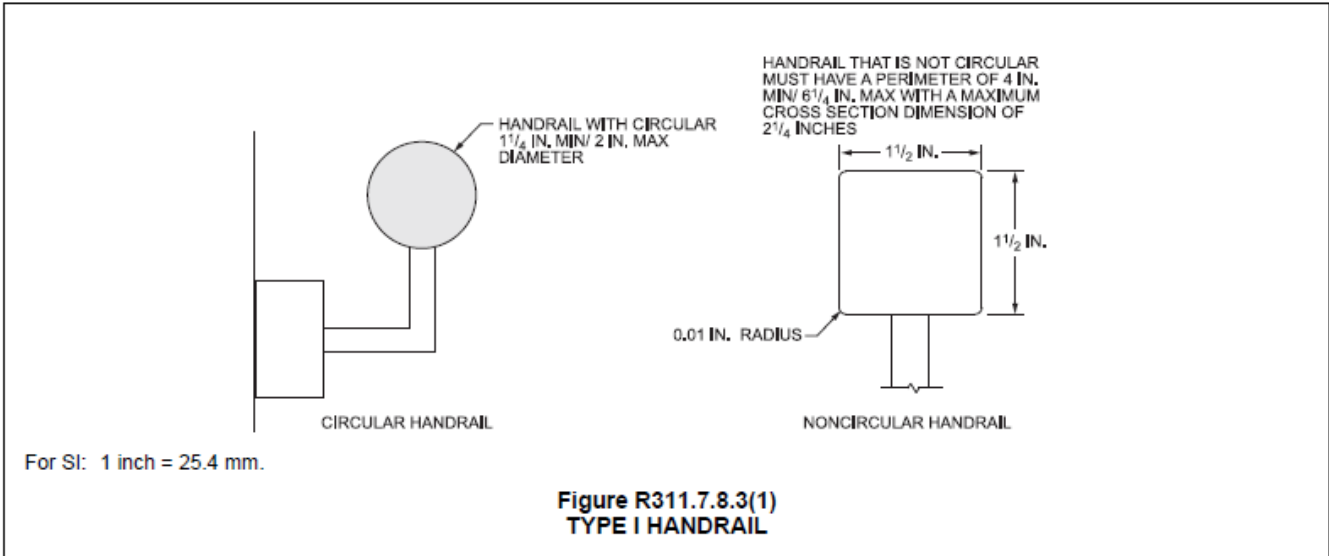

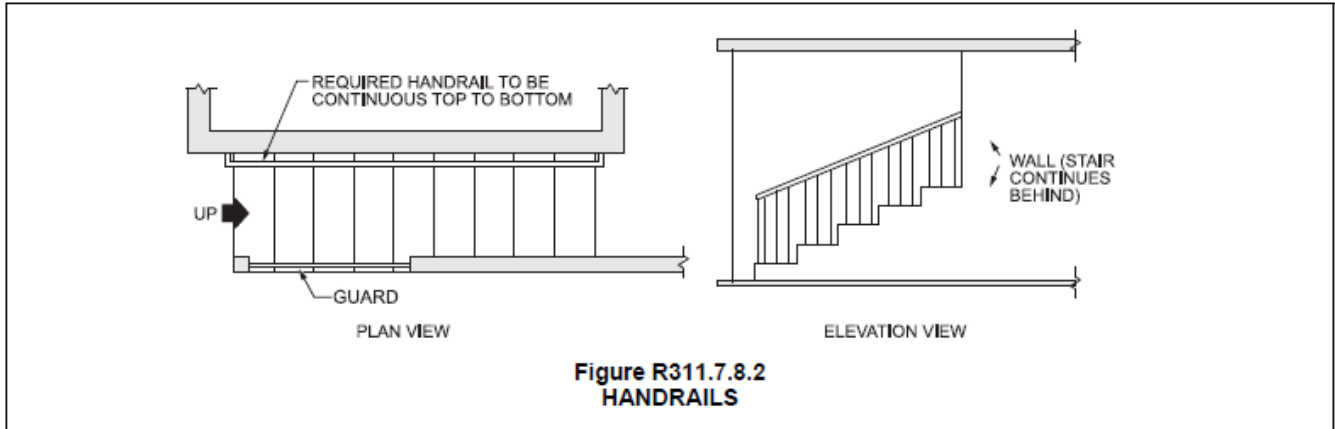

Guards:

- Porches, balconies, ramps or raised floor surfaces located more than 30 inches above the floor or grade below shall have guards not less than 36 inches in height. Open sides of stairs with a total rise of more than 30 inches shall have guards not less than 34 inches in height measured vertically from the nosing of the treads. (see figure R312.1.3 for guards)

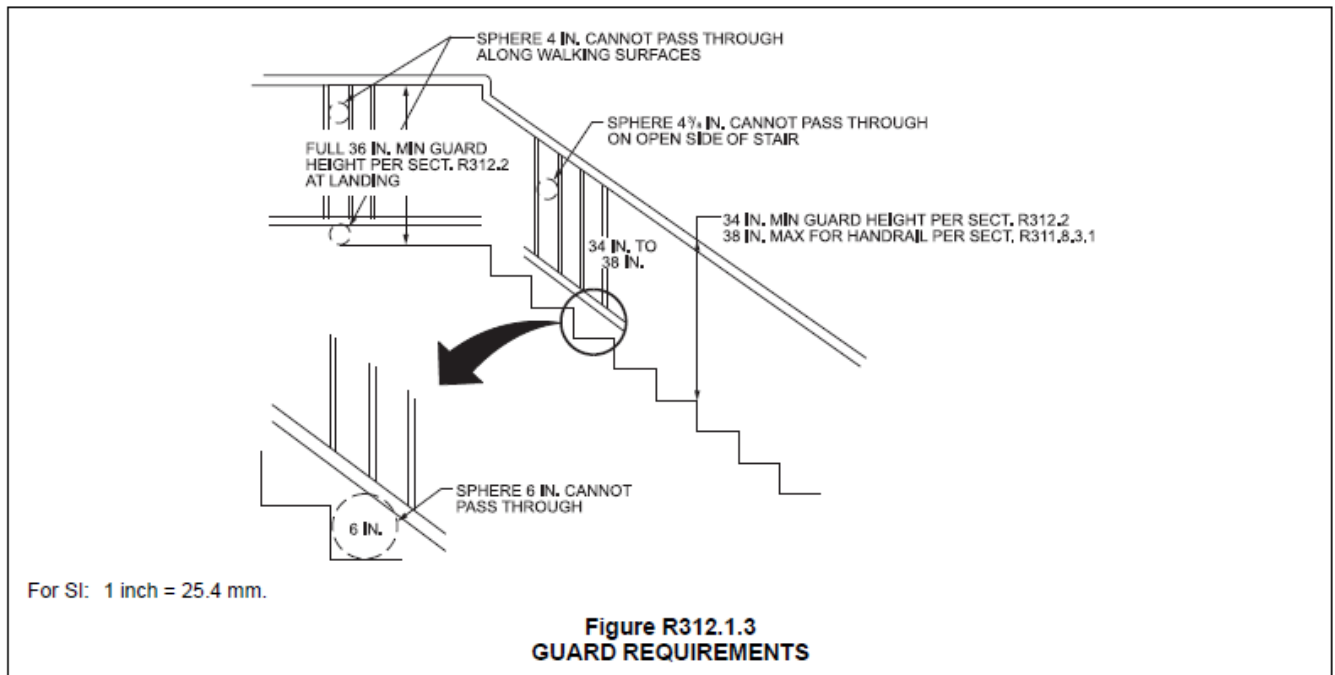



### Smoke alarms:

- Smoke alarms shall be installed in the following locations:  
(see figures R314.3(1))
  1. In each sleeping room.
  2. Outside each separate sleeping area in the immediate vicinity of the bedrooms.
  3. On each additional story of the dwelling, including basements.

Note: Carbon Monoxide detectors are required if dwelling unit contains a fuel fired appliance.

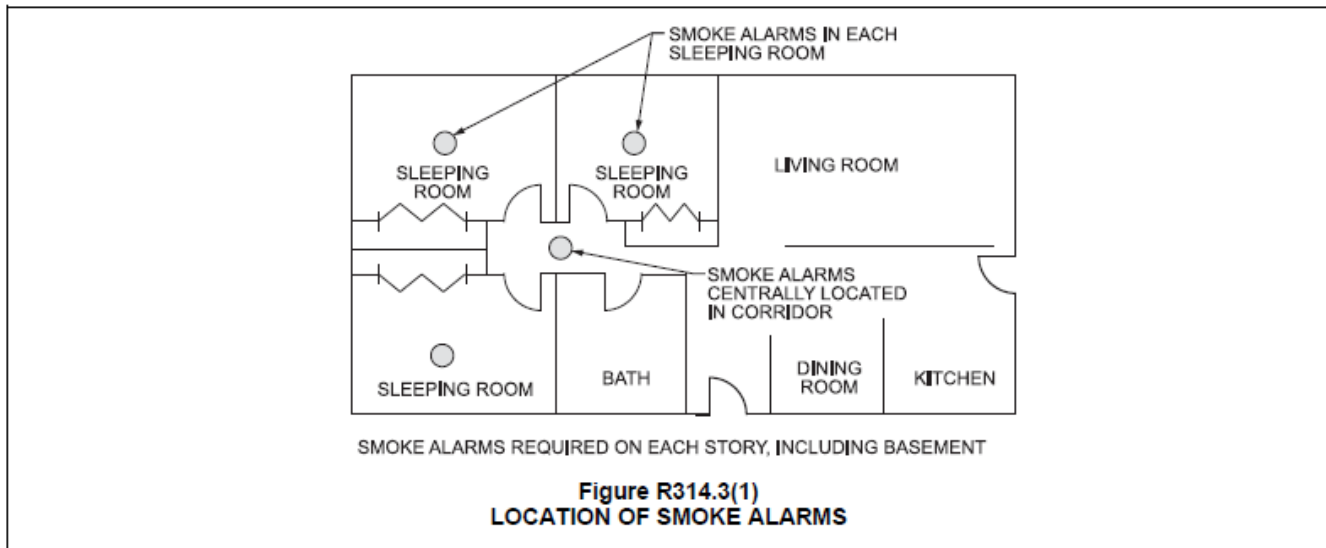

- The smoke detectors shall be interconnected and hardwired. The smoke detectors shall receive their primary power from the building wiring. When primary power is interrupted, they shall receive power from a battery.

### Residential Electrical Requirements

#### Service equipment and location:

- A building shall be supplied by only one service except for a few special conditions.
- The service disconnecting means shall be located outside.
- If the service disconnecting means is not located on the building, then a disconnecting means is required on the building or inside immediately where the conductors enter the building.
- The service to a dwelling unit shall be sized by the calculated load, but in no case smaller than 100 amperes.
- Service and feeder conductor sizes for a dwelling unit shall be:  
100 Ampere-#2 AWG aluminum or #4 AWG copper.  
200 Ampere-#4/0 AWG aluminum or #2/0 AWG copper.

- Equipment grounding conductors shall be:  
100 Ampere-#6 AWG aluminum or #8 AWG copper.  
200 Ampere-#4 AWG aluminum or #6 AWG copper.
- All separate buildings supplied by more than one branch circuit shall have a grounding electrode system installed at the building.
- Breaker boxes shall not be located in bathrooms or clothes closets.
- All 125 volt through 250-volt receptacle outlets located as follows shall be GFCI protected: Bathrooms, Outdoors, Garages and Accessory buildings, Crawlspace, Laundry, basements, Kitchen countertops, Indoor damp and wet locations and where within 6 ft. of a Bathtub or Shower stall, utility or wet bar sink.
- All 120 volt, single phase, 15 and 20 ampere branch circuits supplying outlets or devices in dwelling unit kitchens, family rooms, dining rooms, living rooms, parlors, libraries, dens, bedrooms, sunrooms, recreation rooms, laundry areas, closets, hallways, or similar rooms or areas shall be protected by an arc-fault circuit interrupter to protect the branch circuit.
- Two or more 120-volt, 20 ampere branch circuits are required for kitchen receptacles for small appliances.
- A 120-volt, 20 ampere branch circuit is required for a laundry circuit.
- A 120-volt, 20 ampere branch circuit is required for bathroom receptacle outlets.
- A 120-volt, 20 ampere branch circuit is required for attached and detached garages with electrical power.
- A receptacle outlet is required outside in front and back of the dwelling unit.
- In general, receptacle outlets are to be spaced so that no place along the wall is more than 6 ft. from an outlet. (see exhibit 210.25)
- All 125 and 250-volt nonlocking- type, 15 and 20 ampere receptacles shall be listed tamper-resistant receptacles.

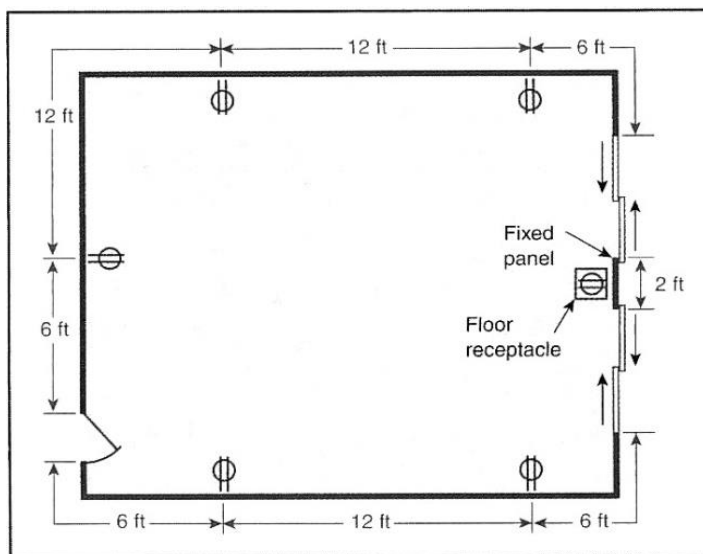

**Exhibit 210.25** Typical room plan view of the location of dwelling unit receptacles meeting the requirements of 210.52(A).

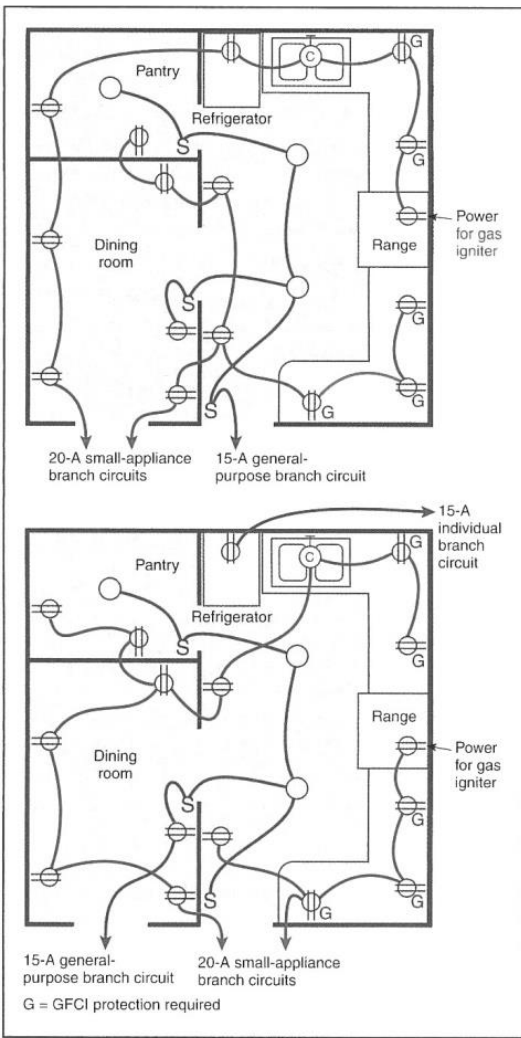

**Exhibit 210.26** Small-appliance branch circuits as required by 210.52(B)(1), (B)(2), and (B)(3) for all receptacle outlets in the kitchen (including refrigerator), pantry, and dining room.

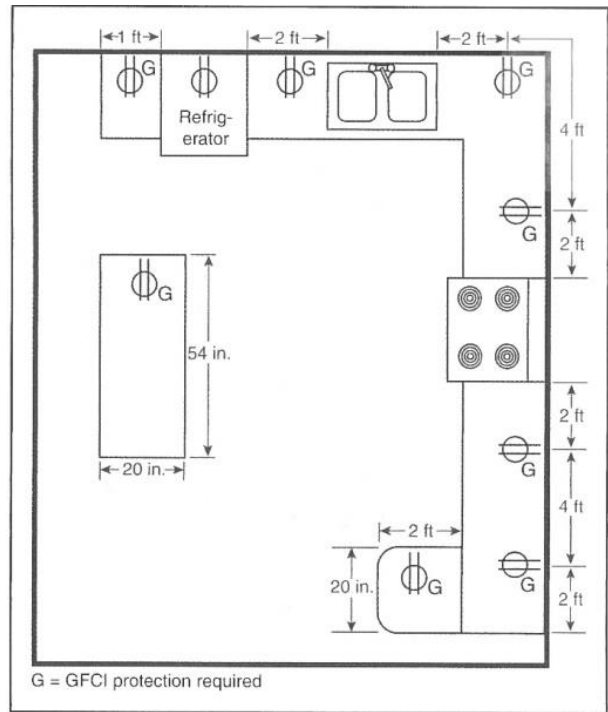

**Exhibit 210.27** Dwelling unit receptacles serving countertop spaces in a kitchen and installed in accordance with 210.52(C).

- For receptacle outlets above kitchen countertops, they shall be spaced so that no place along the wall is more than 2 ft. from an outlet. Island and peninsula countertops are also required to have at least one receptacle outlet. (see exhibit 210.26 and 210.27)
- If lighting fixtures are installed in clothes closets, the following clearances to the nearest point of a storage space must be followed:
  1. 12 inches for surface mounted incandescent or LED fixtures with a completely enclosed light source installed on the wall above the door or on the ceiling.
  2. 6 inches for surface mounted fluorescent fixtures installed on the wall above the door or on the ceiling.
  3. 6 inches for recessed incandescent or LED fixtures with a completely enclosed light source installed in the wall or the ceiling.

(see figure 410.2 closet storage space)

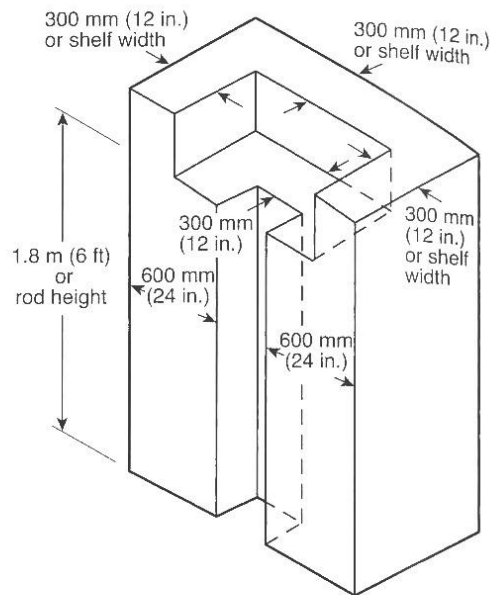

Figure 410.2 Closet Storage Space.

- At least one lighting outlet controlled by a listed wall-mounted control device shall be installed in each habitable room, kitchen, bathroom, hallway, stairway, unfinished basement, attics, underfloor spaces, attached garage, and detached garage with electric power.
- A wall switch controlled lighting outlet shall be provided outside each outdoor entrance or exit.
- Each unfinished basement attached garage and detached garage with electric power shall also have at least one GFCI protected 125volt 15 or 20 ampere receptacle outlet.

### **Residential plumbing requirements**

- All water service pipe and outside waterlines shall be installed not less than 5 ft. 6 inches below grade.
- Water service piping outside shall be rated for not less than 160 PSI.
- PVC water piping shall not be installed inside dwellings.
- Drain, waste and vent piping inside shall be schedule 40.
- All building sewer piping shall be installed not less than 36 inches below grade.

### **Residential mechanical requirements**

- Unvented fuel burning appliances shall not be installed, used, maintained or permitted to exist in any dwelling unit.
- All dwellings shall have make-up air for the exhaust systems provided in the following manner. Piping for the make-up air shall come from the outside of the dwelling to the return-air duct of the HVAC system, or to an opening in a laundry room or other acceptable location. Make-up air piping shall be 4-inch minimum diameter in size.